

**HP 4339B High Resistance Meter**  
**User's Guide**



**HP Part No. 04339-90041**  
**Printed in JAPAN July 1999**

**Third Edition**

---

## **Notice**

The information contained in this document is subject to change without notice.

This document contains proprietary information that is protected by copyright. All rights are reserved. No part of this document may be photocopied, reproduced, or translated to another language without the prior written consent of the Hewlett-Packard Company.

Hewlett-Packard Japan, LTD.  
Kobe Instrument Division  
1-3-2, Murotani, Nishi-Ku, Kobe-shi,  
Hyogo, 651-2241 Japan

## Manual Printing History

|                     |                |
|---------------------|----------------|
| March 1996 .....    | First Edition  |
| December 1996 ..... | Second Edition |
| July 1999 .....     | Third Edition  |

---

## Safety Summary

The following general safety precautions must be observed during all phases of operation, service, and repair of this instrument. Failure to comply with these precautions or with specific **WARNINGS** elsewhere in this manual may impair the protection provided by the equipment. In addition it violates safety standards of design, manufacture, and intended use of the instrument.

*The Hewlett-Packard Company assumes no liability for the customer's failure to comply with these requirements.*

---

### Note



HP 4339B is designed for use in INSTALLATION CATEGORY II according to IEC 61010-1 and POLLUTION DEGREE 1 according to IEC 61010-1 and IEC 60664-1. HP 4339B is an INDOOR USE product.

---

### Note



LEDs in HP 4339B are Class 1 in accordance with IEC60825-1.  
CLASS 1 LED PRODUCT

---

## Ground The Instrument

To avoid electric shock hazard, the instrument chassis and cabinet must be connected to a safety earth ground by the supplied power cable with earth blade.

## DO NOT Operate In An Explosive Atmosphere

Do not operate the instrument in the presence of flammable gasses or fumes. Operation of any electrical instrument in such an environment constitutes a definite safety hazard.

## Keep Away From Live Circuits

Operating personnel must not remove instrument covers. Component replacement and internal adjustments must be made by qualified maintenance personnel. Do not replace components with the power cable connected. Under certain conditions, dangerous voltages may exist even with the power cable removed. To avoid injuries, always disconnect power and discharge circuits before touching them.

## DO NOT Service Or Adjust Alone

Do not attempt internal service or adjustment unless another person, capable of rendering first aid and resuscitation, is present.

## DO NOT Substitute Parts Or Modify Instrument

Because of the danger of introducing additional hazards, do not install substitute parts or perform unauthorized modifications to the instrument. Return the instrument to a Hewlett-Packard Sales and Service Office for service and repair to ensure that safety features are maintained.

## Dangerous Procedure Warnings

**Warnings** , such as the example below, precede potentially dangerous procedures throughout this manual. Instructions contained in the warnings must be followed.

---

**Warning**



**Dangerous voltages, capable of causing death, are present in this instrument. Use extreme caution when handling, testing, and adjusting this instrument.**

---

## Certification

Hewlett-Packard Company certifies that this product met its published specifications at the time of shipment from the factory. Hewlett-Packard further certifies that its calibration measurements are traceable to the United States National Institute of Standards and Technology, to the extent allowed by the Institution's calibration facility, or to the calibration facilities of other International Standards Organization members.

---

## Warranty

This Hewlett-Packard instrument product is warranted against defects in material and workmanship for a period of one year from the date of shipment, except that in the case of certain components listed in *General Information* of this manual, the warranty shall be for the specified period. During the warranty period, Hewlett-Packard Company will, at its option, either repair or replace products that prove to be defective.

For warranty service or repair, this product must be returned to a service facility designated by HP. Buyer shall prepay shipping charges to HP and HP shall pay shipping charges to return the product to Buyer. However, Buyer shall pay all shipping charges, duties, and taxes for products returned to HP from another country.

HP warrants that its software and firmware designated by HP for use with an instrument will execute its programming instruction when properly installed on that instrument. HP does not warrant that the operation of the instrument, or software, or firmware will be uninterrupted or error free.

---

## Limitation Of Warranty

The foregoing warranty shall not apply to defects resulting from improper or inadequate maintenance by Buyer, Buyer-supplied software or interfacing, unauthorized modification or misuse, operation outside the environmental specifications for the product, or improper site preparation or maintenance.

*No other warranty is expressed or implied. HP specifically disclaims the implied warranties of merchantability and fitness for a particular purpose.*

## **Exclusive Remedies**

*The remedies provided herein are buyer's sole and exclusive remedies. HP shall not be liable for any direct, indirect, special, incidental, or consequential damages, whether based on contract, tort, or any other legal theory.*

---

## **Assistance**

Product maintenance agreements and other customer assistance agreements are available for Hewlett-Packard products.

For any assistance, contact your nearest Hewlett-Packard Sales and Service Office. Addresses are provided at the back of this manual.

## Safety Symbols

General definitions of safety symbols used on equipment or in manuals are listed below.



Instruction manual symbol: the product is marked with this symbol when it is necessary for the user to refer to the instruction manual.



Alternating current.



Direct current.



On (Supply).



Off (Supply).

### Warning



This **Warning** sign denotes a hazard. It calls attention to a procedure, practice, condition or the like, which, if not correctly performed or adhered to, could result in injury or death to personnel.

### Caution



This **Caution** sign denotes a hazard. It calls attention to a procedure, practice, condition or the like, which, if not correctly performed or adhered to, could result in damage to or destruction of part or all of the product.

### Note



**Note** denotes important information. It calls attention to a procedure, practice, condition or the like, which is essential to highlight.



Affixed to product containing static sensitive devices use anti-static handling procedures to prevent electrostatic discharge damage to component.





Caution, risk of electric shock : Terminals which may be supplied from the interior of the equipment at a voltage exceeding 1 kV, or allow connection to a voltage exceeding 1 kV are marked with this symbol.

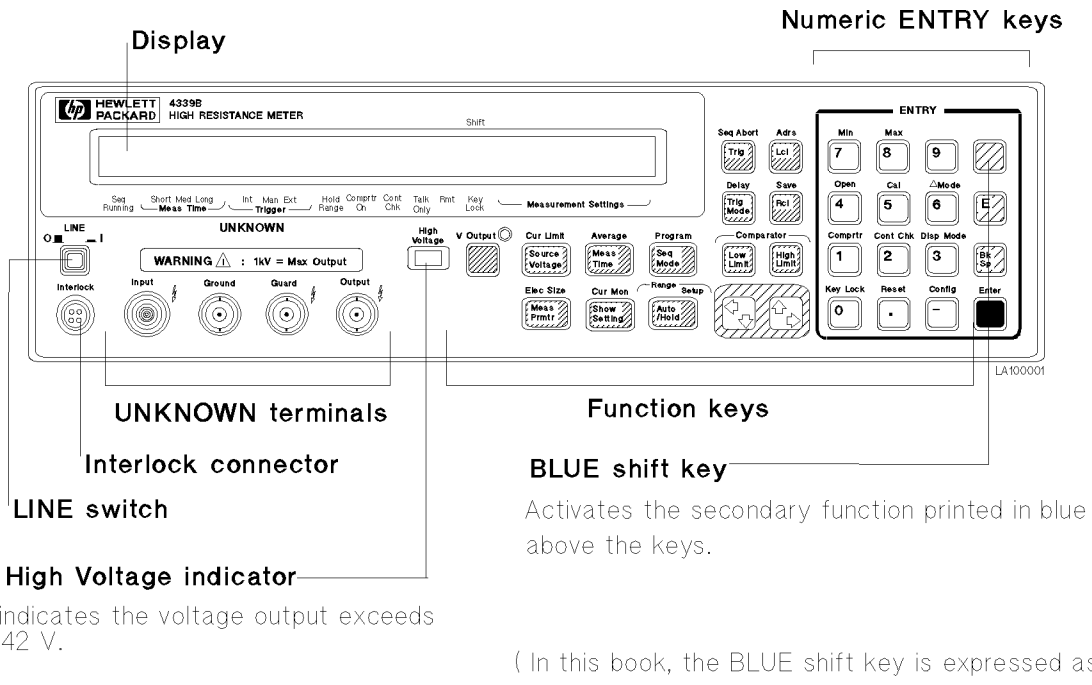

**HP 4339B**

**HP 4339B High Resistance Meter at a Glance.**



**Warning**  **Do not touch the UNKNOWN terminals or the electrodes of the accessory, when the High Voltage indicator is ON.**

**Annunciator** (  symbols, at the bottom of the display )

Shows the instrument's operational state. For example,

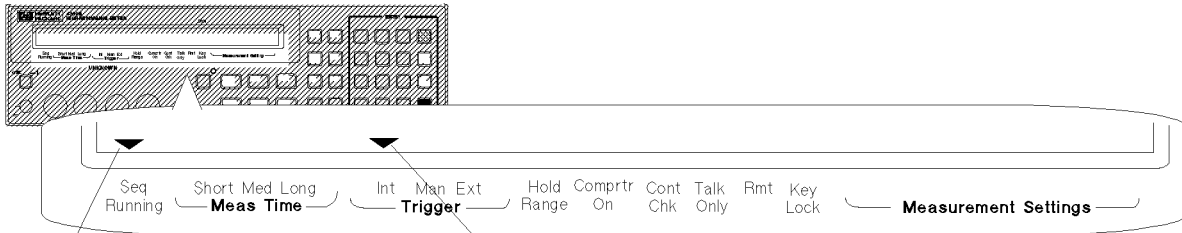

Indicates the measurement sequence single mode is selected.

Indicates that internal trigger is selected.

LA100003

---

## In User's Guide

- Chapter 1, Preparation for Use

  - For initial turn on of the HP 4339B

- Chapter 2, Operating the HP 4339B

  - Basic measurement operation

    - Getting acquainted with the HP 4339B—for beginners

    - Handy reference for common measurement tasks—for all users

- Chapter 3, Measurement Examples

  - Measurement Examples for typical HP 4339B applications

    - Measuring Insulation Resistance of a Capacitor

    - Measuring Volume Resistivity of a Insulation Material



In the User's Guide, information on the following subjects is not discussed:



- Initial Inspection
- HP-IB remote control
- Using with Handler
- Maintenance
- Specifications
- Error Messages

For detailed information on these subjects, see the *HP 4339B Operation Manual*.

# Contents

---

|   |      |
|---|------|
| <b>1. Preparation for Use</b>   |      |
| In This Chapter . . . . .   | 1-1  |
| Power Requirements . . . . .  | 1-1  |
| To Set Power LINE Voltage . . . . .   | 1-1  |
| To Set Power LINE Frequency . . . . .   | 1-2  |
| <b>2. Operating the HP 4339B</b>  |      |
| In This Chapter . . . . .   | 2-1  |
| To Reset HP 4339B to its Default Settings . . . . .   | 2-2  |
|  To Connect Test Fixture . . . . . | 2-2  |
| HP 16008B Resistivity Cell . . . . .  | 2-2  |
| HP 16117B Low Noise Test Lead . . . . .   | 2-3  |
| HP 16339A Component Test Fixture . . . . .  | 2-3  |
| To Perform Calibration—Canceling internal measurement errors . . . . .  | 2-4  |
| To Set Test Voltage . . . . .   | 2-4  |
| To Set Current Limit . . . . .  | 2-4  |
|  To Perform OPEN Correction      |      |
| —Canceling the stray admittance in parallel with the DUT . . . . .  | 2-5  |
| If “Out Of Limit” is displayed . . . . .  | 2-5  |
|  To Connect DUT . . . . .        | 2-6  |
| To Select Measurement Parameter . . . . .   | 2-6  |
| Setting the Parameters for Resistivity Measurement . . . . .  | 2-7  |
| Setting Thickness of the DUT . . . . .  | 2-7  |
| Setting the Electrode Size . . . . .  | 2-7  |
| To Select Measurement Range . . . . .   | 2-8  |
| Auto Range mode—Automatically selecting the optimum measurement range . . . . .                                     | 2-8  |
| Hold Range mode—Holding the measurement range of your choice . . . . .  | 2-8  |
| To Select Measurement Time Mode . . . . .   | 2-8  |
| To Set Averaging Rate—Stabilizing the measurement result . . . . .  | 2-9  |
| To Select Trigger Mode . . . . .  | 2-9  |
| To Set Trigger Delay Time . . . . .   | 2-9  |
| To Use Deviation Measurement Function . . . . .   | 2-10 |
| Setting the Deviation Reference Values . . . . .  | 2-10 |
| Selecting the Deviation Mode . . . . .  | 2-10 |
| To Use Comparator Function . . . . .  | 2-11 |
| Setting the Limit Values . . . . .  | 2-11 |
| Sorting . . . . .   | 2-11 |
| To Select Display Mode . . . . .  | 2-12 |
| To Select Beeper Mode . . . . .   | 2-13 |
| To Use Contact Check Function —Monitoring the connection of test electrodes and DUT . . . . .                       | 2-13 |
| To Print Measurement Data . . . . .   | 2-14 |
| Setting the Printer . . . . .   | 2-14 |

|   |      |
|---|------|
| Printing . . . . .  | 2-14 |
| Disabling Printing . . . . .  | 2-14 |
| To Use Measurement Sequence Function  |      |
| —Controlling charge-measurement in a sequence . . . . .   | 2-15 |
| Selecting the Measurement Sequence Mode . . . . .   | 2-15 |
| Setting the Measurement Sequence . . . . .  | 2-15 |
|  Starting Measurement Sequence . . . . . | 2-16 |
| Aborting Measurement Sequence . . . . .   | 2-16 |
|  To Apply Test Voltage . . . . .         | 2-16 |
| To Trigger a Measurement . . . . .  | 2-16 |
|  To Turn OFF Voltage Output . . . . .    | 2-16 |
| Reference . . . . .   | 2-17 |
| Default Settings . . . . .  | 2-17 |
| Accessories Available . . . . .   | 2-17 |
| Test Fixtures and Test Leads . . . . .  | 2-17 |
| HP 16064B LED Display/Trigger Box . . . . .   | 2-19 |
| Other Topics . . . . .  | 2-20 |
| If You Have a Problem . . . . .   | 2-20 |

### 3. Measurement Examples

|   |     |
|---|-----|
|  In This Chapter . . . . . | 3-1 |
| Measuring Insulation Resistance of Capacitor . . . . .  | 3-2 |
| Measurement Setup . . . . .   | 3-2 |
| Measurement Procedure . . . . .   | 3-2 |
| For More Information . . . . .  | 3-5 |
| Measuring Resistivity of Insulation Material . . . . .  | 3-6 |
| Measurement Setup . . . . .   | 3-6 |
| Measurement Procedure . . . . .   | 3-6 |
| For More Information . . . . .  | 3-9 |

# Figures

---

|                               |      |
|-------------------------------|------|
| 2-1. Printer Output . . . . . | 2-14 |
|-------------------------------|------|

# Tables

---

|   |     |
|---|-----|
| 1-1. Power Voltage Selector Setting . . . . . | 1-1 |
|---|-----|



## Preparation for Use

### In This Chapter

Before turning the HP 4339B ON, you must first set the HP 4339B to match the available power LINE voltage.

If the HP 4339B's power LINE voltage and frequency are properly set and ready to use, you can skip this chapter.

### Power Requirements

The HP 4339B's power source requirements are as follows:

**LINE Voltage** : 100 / 120 / 220 / 240 V ac ( $\pm 10\%$ )



**LINE Frequency** : 47 to 66 Hz

**Power Consumption** : 45 VA maximum

### To Set Power LINE Voltage

1. Confirm that the power cable is disconnected.
2. Slide the LINE Voltage selector on the rear panel to match the power LINE voltage which will be used (see Table 1-1).

**Table 1-1. Power Voltage Selector Setting**

| Voltage Selector  | Line Voltage              | Required Fuse  |
|---|---------------------------|--|
|  | 100V/120Vac( $\pm 10\%$ ) | UL/CSA type, Time delay 0.5A 250V<br>(HP part number 2110-0202)  |
|  | 220V/240Vac( $\pm 10\%$ ) | UL/CSA type, Time delay 0.25A 250V<br>(HP part number 2110-0201) |

### HP 4339B Rear Panel

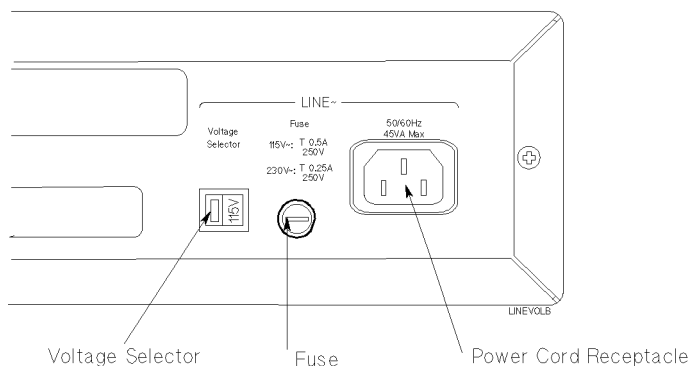

## To Set Power LINE Frequency

1. Connect the power cable to the power cord receptacle on the rear panel.
2. Push the LINE switch in. The HP 4339B will emit a beep and perform the self test. (If any message is displayed, see “Error Messages” back of *HP 4339B Operation Manual*.) The HP 4339B will be ready for operation after a message like the following is displayed.

LA001005

```



HP 4339B  Rev.  xx.xx
          Dec. 13 1995
  
```

3. Press  . The following menu is displayed.

LA001034

```



R: +0.0000  Ω                Vout:  0.000 V
Offset Beep Exit  more      Clmt: 500.0 μA
  
```

4. Press  until more blinks, and press .

LA001134

```

R: +0.0000  Ω                Vout:  0.000 V
Line Svc Test Exit  more      Clmt: 500.0 μA
  
```



5. Press  until Line blinks, and press .

LA001116

```

R: +0.0000  Ω                Vout:  0.000 V
LINE FREQ:  50Hz  60Hz      Clmt: 500.0 μA
  
```

A blinking item means that it is currently selected.

6. If the setting does not match the power LINE frequency, press  to toggle the setting between 50Hz and 60Hz, then press .
7. Select Exit and press  to exit this menu.

### Note



The power line frequency setting is stored and is not changed after reset or power-off. Once you set it, you do not need to set the line frequency again as long as the same power line frequency is being used.





## **Operating the HP 4339B**

---



### **In This Chapter**

Basic measurement operations of the HP 4339B and references are explained.

## To Reset HP 4339B to its Default Settings

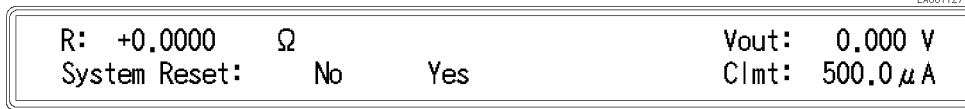
1. Press   to select the reset menu.





2. Press  until Yes blinks, and press .

For more information about the default settings, see “Default Settings” later in this chapter.

## To Connect Test Fixture

Connect the test fixture to the UNKNOWN terminals as follows:

**Warning**  Do not touch the UNKNOWN terminals or the electrodes of the accessory, when the High Voltage indicator is ON, the HP 4339B outputs dangerous voltage of up to 1000 Vdc. Before handling the HP 4339B or the accessory, turn OFF the test voltage pressing  and confirm that the High Voltage indicator is OFF.

## HP 16008B Resistivity Cell

The HP 16008B is used to measure the volume or surface resistance/resistivity of insulation materials.

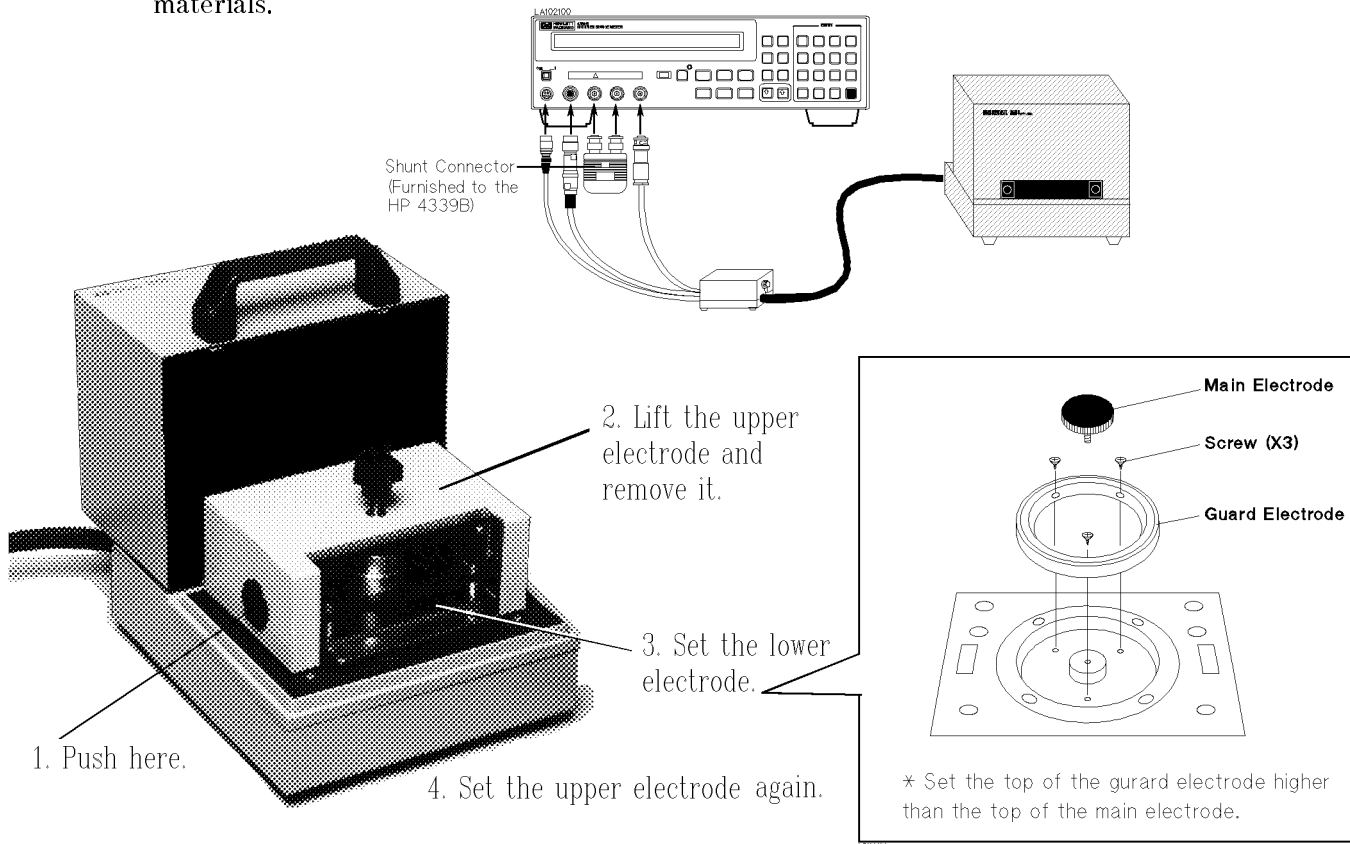

Three size electrodes are available. For detail see “Accessories Available” later in this chapter.

## HP 4339B

### HP 16117B Low Noise Test Lead

The HP 16117B is used to measure the resistance of insulation materials.

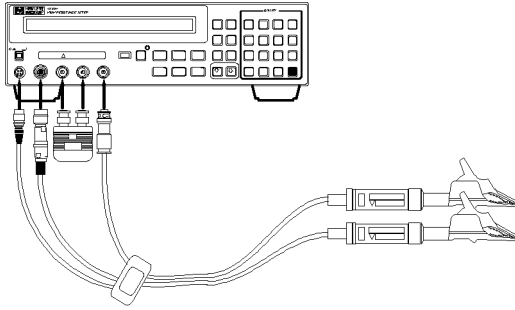

For floating DUT measurement

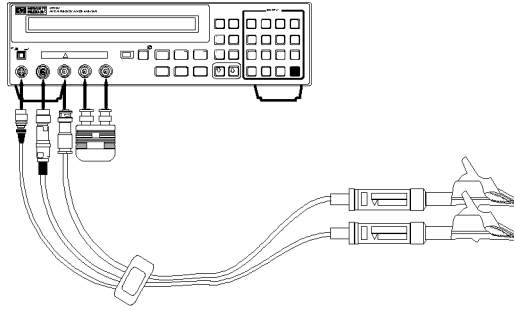

For grounded DUT measurement

### HP 16339A Component Test Fixture

The HP 16339A is used to measure insulation resistance of electronic components.

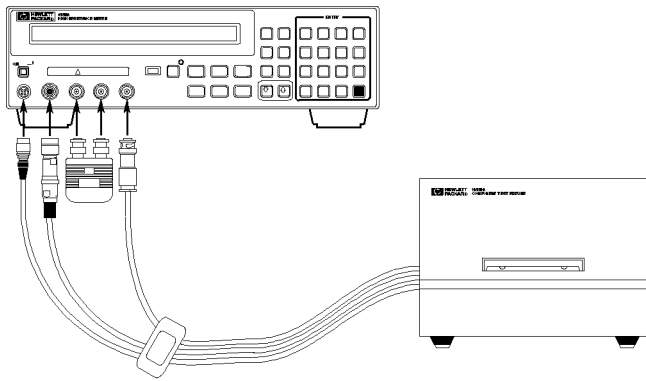

Top view (cover is opened)  
of the HP 16339A

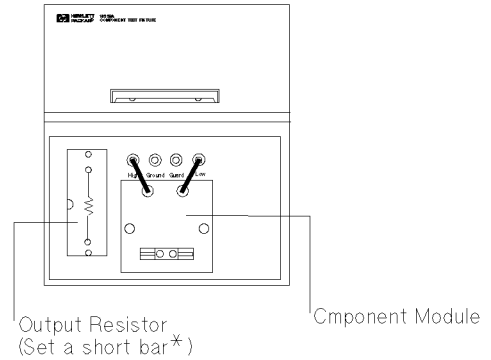

To set the component module :

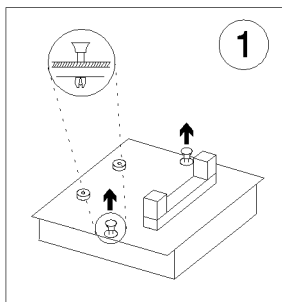

Pull the clamps up.

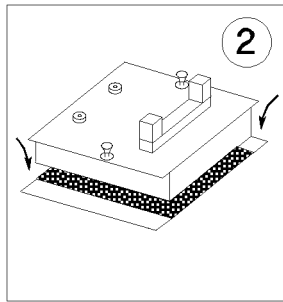

Insert the module.

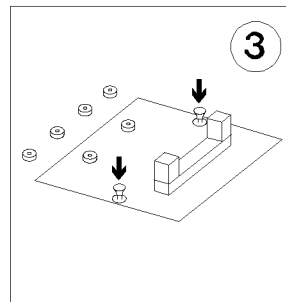

Push the clamps down.

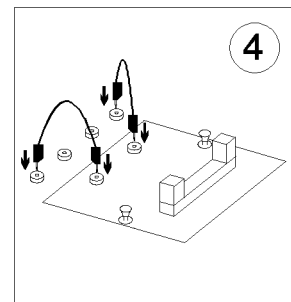

connect the banana cables.



Three type modules are available. For detail see "Accessories Available" later in this chapter.

\* Measuring a high capacitance DUT keeping good S/N ratio, change the short bar to an appropriate resistor. For detail, see page 3-6 of *HP 16339A Component Test Fixture Operation and Service Manual*.

## To Perform Calibration—Canceling internal measurement errors

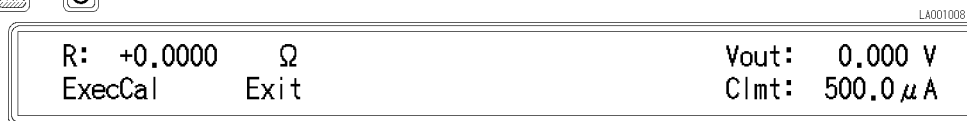
1. Press   **5** .





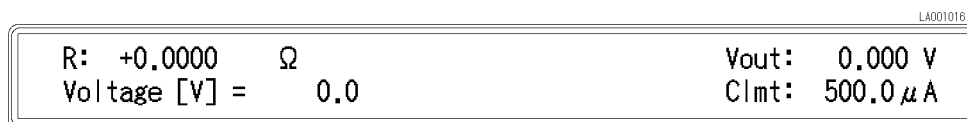

2. Select ExecCal using  or  and press  . The HP 4339B will perform the calibration. After the calibration is completed with the message Calibration Complete, the HP 4339B will return to the measurement display.

## To Set Test Voltage

1. Press  . The voltage setting menu will be displayed.



2. Enter the value using the numeric ENTRY keys (for example, to set 100 V, press  **1**  **1**  **0** ), then press  .

## To Set Current Limit

1. Press   .

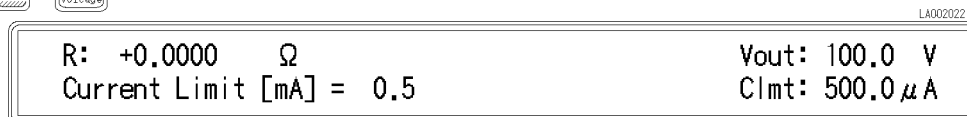

2. Enter the current limit value using the numeric keys, then press  to enter the value and to exit.



Available current limits are:

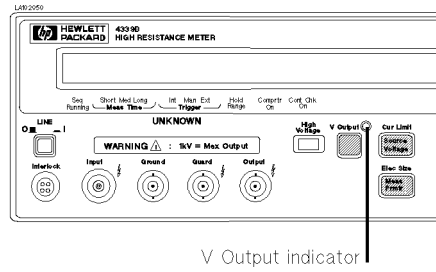

- |  |  |
|--|--|
| 0.5 mA (default)                         | 5.0 mA (at test voltage 0 to 250 V only) |
| 1.0 mA                                   | 10 mA (at test voltage 0 to 100 V only)  |
| 2.0 mA (at test voltage 0 to 500 V only) |  |

## ⚠ To Perform OPEN Correction —Canceling the stray admittance in parallel with the DUT

1. Separate each electrode of the test fixture. For details about fixture operation, refer to “Test Fixtures and Test Leads” later in this chapter.
2. Press . A source voltage is applied to the test fixture, and the **V Output** indicator will turn ON.



**Warning**  Pressing  may cause the HP 4339B to output dangerous voltage, up to 1000 Vdc. Do *not* touch the UNKNOWN terminals or the electrodes of the accessory when the V Output indicator is ON.

3. Press  . The OPEN correction menu will be displayed.

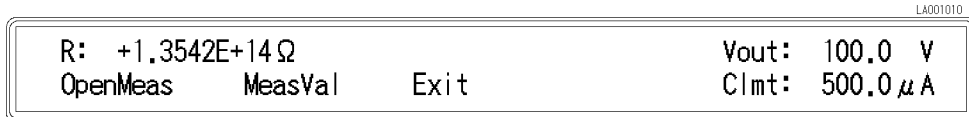

4. Select **OpenMeas** using  or  and press . The HP 4339B will perform the OPEN correction.

After a while, the HP 4339B will display the message **Correction Complete**, and return to the measurement mode.

5. Press  to turn the voltage OFF. The **V Output** indicator will turn OFF.

### If “Out Of Limit” is displayed



The OPEN admittance is so high that it would be unsuitable for OPEN correction data.

- Check that the test electrodes are properly opened.

Perform the OPEN correction again.

## To Connect DUT



Set the DUT to the test fixture. For details, see “Test Fixtures and Test Leads”.

**Warning**  Do *not* touch the UNKNOWN terminals or the electrodes of the accessory, when the High Voltage indicator is ON, the HP 4339B outputs dangerous voltage of up to 1000 Vdc. Before handling the HP 4339B or the accessory, turn OFF the test voltage pressing  and confirm that the High Voltage indicator is OFF.

## To Select Measurement Parameter

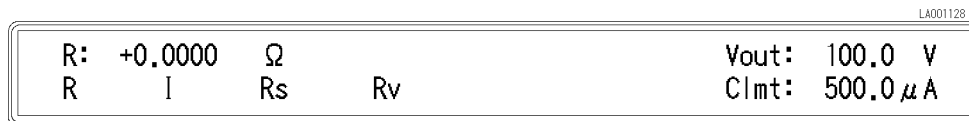
- Press . The measurement parameter selection menu will be displayed.



- Select the desired parameter using  or  and press . (R:Resistance, I:Current, Rv:Volume resistivity  $\rho_v$ , Rs:Surface resistivity  $\rho_s$ )

**Note**  If the HP 16008B resistivity cell is connected to the HP 4339B, to change volume and surface resistivity, switch the volume/surface selector on the resistivity cell.

## HP 4339B

### Setting the Parameters for Resistivity Measurement

If you measure the volume or surface resistivity, set the parameters as follows:

Press   .

LA002006

|                              |                     |
|------------------------------|---------------------|
| R: +0.0000 $\Omega$          | Vout: 0.000 V       |
| Thickness    Rescell    Exit | Clmt: 500.0 $\mu$ A |

### Setting Thickness of the DUT

1. Select Thickness using  or  and press  .

LA002007

|                         |                     |
|-------------------------|---------------------|
| R: +0.0000 $\Omega$     | Vout: 0.000 V       |
| Thickness [mm] = 2.0000 | Clmt: 500.0 $\mu$ A |

2. Enter the thickness value using the numeric ENTRY keys, and press  .

LA002008



|                              |                     |
|------------------------------|---------------------|
| R: +0.0000 $\Omega$          | Vout: 0.000 V       |
| Thickness    Rescell    Exit | Clmt: 500.0 $\mu$ A |

### Setting the Electrode Size

1. Select ResCell using  or  and press  .

LA002008

|                                |                     |
|--------------------------------|---------------------|
| R: +0.0000 $\Omega$            | Vout: 0.000 V       |
| 26    50    76    User    Exit | Clmt: 500.0 $\mu$ A |

2. Select the electrode size that you want to use (26mm, 50mm, or 76mm) using  or  , and press  .

LA002009

|                              |                     |
|------------------------------|---------------------|
| R: +0.0000 $\Omega$          | Vout: 0.000 V       |
| D: 50mm - 70mm    B = 0.0000 | Clmt: 500.0 $\mu$ A |

3. Press  .

LA002006

|                              |                     |
|------------------------------|---------------------|
| R: +0.0000 $\Omega$          | Vout: 0.000 V       |
| Thickness    Rescell    Exit | Clmt: 500.0 $\mu$ A |

4. Select Exit and press  to exit the menu.

## To Select Measurement Range

### Auto Range mode

#### —Automatically selecting the optimum measurement range



Press . The **Hold Range** annunciator(▼) turns OFF.

### Hold Range mode—Holding the measurement range of your choice

To select the measurement range,

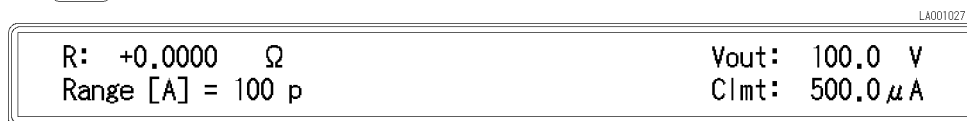
1. Press  . The measurement range setup menu is displayed.



2. Press  or  until the desired range is displayed. Or, input the current value to be measured using the numeric ENTRY keys, and the HP 4339B will select the optimum measurement range setting.
3. Press . The **Hold Range** annunciator(▼) turns ON.

Available measurement ranges:

100 pA (Not available at measurement time Short)  
 1 nA  
 10 nA  
 100 nA  
 1  $\mu$ A  
 10  $\mu$ A  
 100  $\mu$ A (Available at measurement time Short only)

## To Select Measurement Time Mode





Press  until the **Meas Time** annunciator(▼) points to the desired measurement time mode : **Short**, **Med**(Medium) or **Long**.



## To Set Averaging Rate—Stabilizing the measurement result

1. Press  .



2. Enter the averaging rate using the numeric ENTRY keys. (For example, to enter 4, press .) You can enter integer values from 1 to 256. Also, you can increase or decrease the value using  or .
3. Press  to set the value and to exit.

## To Select Trigger Mode

Press  until the **Trigger** annunciator(▼) points to the desired trigger mode.

**Int**(Internal) Free running measurement

**Man**(Manual) Triggers a measurement when  is pressed.





**Ext**(External) Triggers a measurement by external trigger signal input (through the external trigger connector or handler interface).

To trigger a measurement in each mode, see “To Trigger a Measurement” later in this chapter.

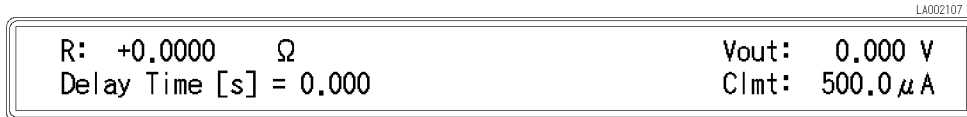
## To Set Trigger Delay Time

1. Press  .



2. Enter the desired trigger delay time using the numeric ENTRY keys. (For example, to set 0.5 s, press   .) You can set the trigger delay time from 0 s to 9.999 s.
3. Press  to set the value and to exit.

## To Use Deviation Measurement Function

### Setting the Deviation Reference Values

1. Press  .

LA002116

|            |                 |                     |
|------------|-----------------|---------------------|
| R: +0.0000 | $\Omega$        | Vout: 100.0 V       |
| ModeSet    | $\Delta$ RefEnt | Clmt: 500.0 $\mu$ A |
|            | Exit            |                     |

2. Select  $\Delta$ RefEnt using  or  and press .

LA002016

|                              |          |                     |
|------------------------------|----------|---------------------|
| R: +0.0000                   | $\Omega$ | Vout: 100.0 V       |
| $\Delta$ Reference = +0.0000 |          | Clmt: 500.0 $\mu$ A |

3. Enter the numeric value using the numeric ENTRY keys.



4. Press  to enter the value.

### Selecting the Deviation Mode

5. Select ModeSet using  or  and press .

LA002117

|            |                         |                     |
|------------|-------------------------|---------------------|
| R: +0.0000 | $\Omega$                | Vout: 100.0 V       |
| Off        | $\Delta$ ABS $\Delta$ % | Clmt: 500.0 $\mu$ A |

6. Select the desired mode using  or  and press .

$\Delta$ ABS mode: Measured value–Reference

LA002017

|                     |          |                     |
|---------------------|----------|---------------------|
| $\Delta$ R: +0.0000 | $\Omega$ | Vout: 100.0 V       |
|                     |          | Clmt: 500.0 $\mu$ A |

$\Delta$ % mode: (Measured value–Reference)/Reference  $\times$  100 %

LA002028

|                        |  |                     |
|------------------------|--|---------------------|
| $\Delta$ R: +9.9E+37 % |  | Vout: 100.0 V       |
|                        |  | Clmt: 500.0 $\mu$ A |

## To Use Comparator Function

### Setting the Limit Values

1. Press .



2. Enter the lower limit value using the numeric ENTRY keys, then press  to enter the value. You can set the value from  $-9.900 \times 10^{37}$  to  $9.900 \times 10^{37}$ .

3. Press .

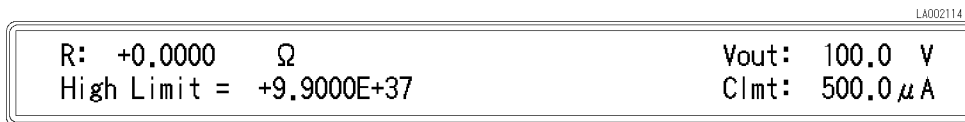

4. Enter the upper limit value using the numeric ENTRY keys, then press  to enter the value and to exit. You can set the value from  $-9.900 \times 10^{37}$  to  $9.900 \times 10^{37}$ .

### Sorting

To start sorting,

Press  . The **Comprtr On** annunciator(▼) turns ON.

To turn sorting OFF,

Press   again. The **Comprtr On** annunciator turns OFF.

The sorting results are HIGH, IN, and LOW.

Where,

HIGH            greater than higher limit  
 IN              between higher limit and lower limit  
 LOW            less than lower limit

The HP 4339B shows the comparison results using the display, beeper, printer, and HP 16064B LED Display/Trigger Box. (To use the HP 16064B, see “Accessories Available” later in this chapter.)

- For result output to the display, see “To Select Display Mode” in the next page.
- For result output to the beeper, see “To Select Beeper Mode” in the next page.
- For result output to the printer, see “To Print Measurement Data” later in this chapter.

## To Select Display Mode

Press   .





Select the desired mode using  or  and press  .

(Data:Measurement Display, Comprtr:Comparison Display, Off:Display OFF)

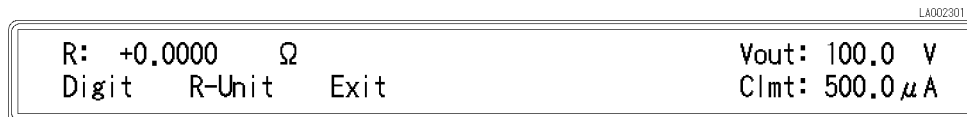
If you select **Formt**, the following menu will be displayed. You can select the display digits and display format of the Measurement Display mode.



To select the display digits, select **Digit** and press  . Then select the display digits from 3, 4 or 5.

To select the display format for the measurement data, select **R-Unit** and press  . Then select **Exponent** mode or **Prefix** mode.

Each display mode shows the result as follows:

- The Measurement Display mode shows the measurement data:

Exponent mode

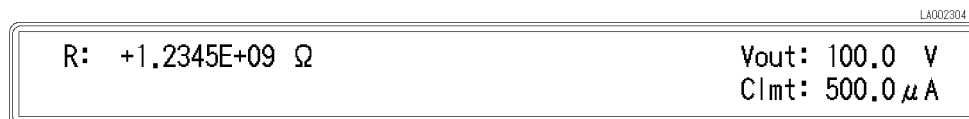

Prefix mode

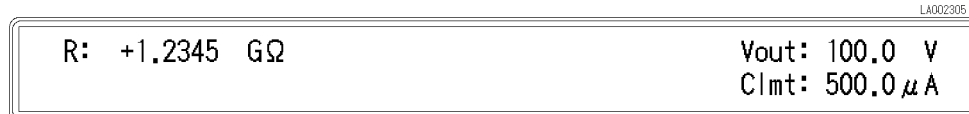

- The Comparison Display mode shows the comparison results:



- The Display OFF mode (DISP OFF) does not show any measurement result.

## To Select Beeper Mode



To change the beeper mode for the comparator result reporting:

1. Press  .



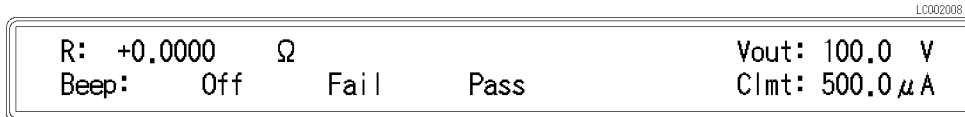

2. Select Beep using  or  and press  to select.



3. Select the beep mode using  or , and press  to exit to the previous display.

- OFF No beep
- FAIL Emits a beep when the comparator result is HIGH, LOW, or the contact check FAILED.
- PASS Emits a beep when the comparator result is IN.



4. Select Exit using  or , and press  to exit.

## To Use Contact Check Function —Monitoring the connection of test electrodes and DUT

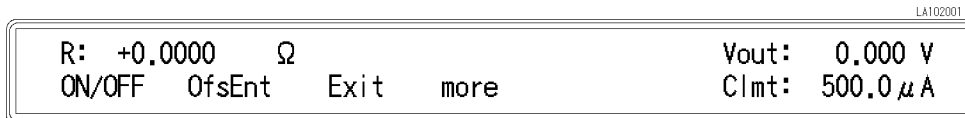

To enable or disable the contact check function:

1. Press  .

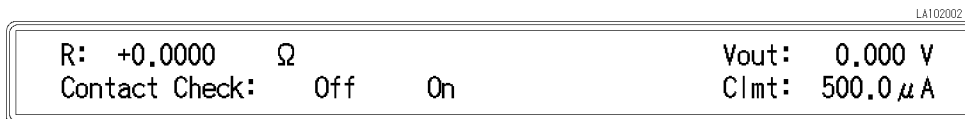

2. Select ON/OFF using  or  and press  to select.



3. Select On or Off using  or , and press  to exit to the previous display.

4. Select Exit using  or , and press  to exit.

5. The **Cont Chk** annunciator(▼) turns ON if the contact check function is on.

When contact check failed, the HP 4339B displays N.C.(No-Contact). The limit value for the contact check function is changable. Refer to *Operation Manual*.

The OPEN correction function must be performed correctly for a valid contact check.

## To Print Measurement Data

### Setting the Printer

1. Use an HP-IB compatible printer, set to the listen-always mode.
2. Connect the printer to the HP 4339B's HP-IB port on the rear panel.
3. Turn the printer ON.

### Printing

Set the HP 4339B to talk only mode (Set the HP 4339B's HP-IB address to 31).

1. Press    .

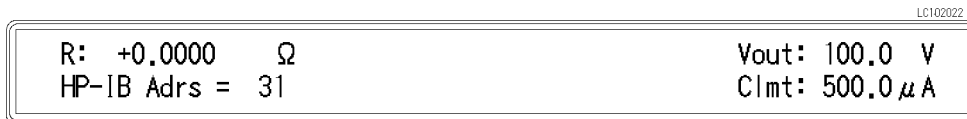

2. Press . The **Talk Only** annunciator(▼) turns ON, and the printer begins printing the measurement data.

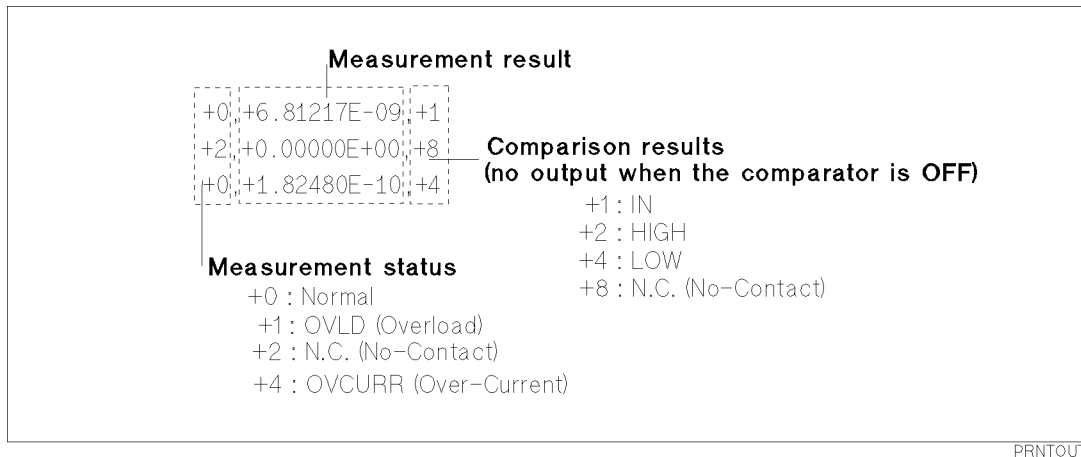

Figure 2-1. Printer Output

### Disabling Printing

Change the HP-IB address to an address other than 31 (for example, 17, which is the default setting).

- Press     .

## To Use Measurement Sequence Function —Controlling charge-measurement in a sequence

### Selecting the Measurement Sequence Mode

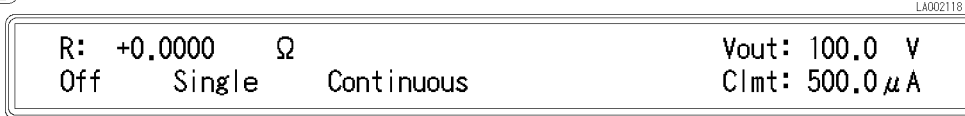

Press  .



Select the desired mode using  or  and press  .

Single            Single mode  
Continuous      Continuous mode  
Off                Measurement sequence OFF (normal measurement mode)

### Setting the Measurement Sequence

1. Press   . The sequence mode menu will be displayed.

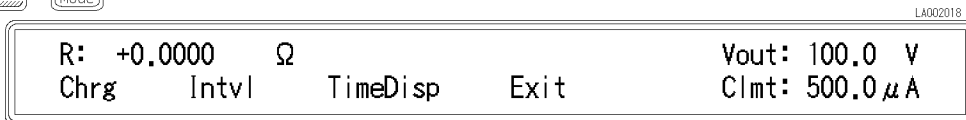

2. Set Charge time.

a. Select Chrg using  or  and press  .

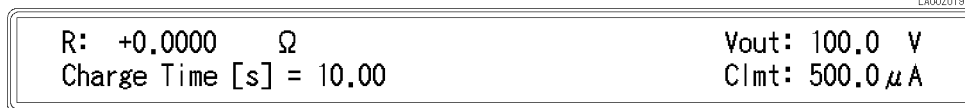

b. Enter the charge time using the numeric ENTRY keys, and press  .

3. Set Interval time and Number of repetitions (**Cont** mode only).

a. Select Intvl using  or  and press  .

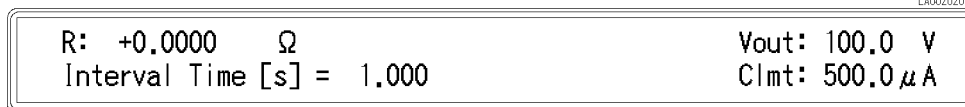

b. Enter the interval time using the numeric ENTRY keys, and press  .





c. Enter the number of measurement points (equivalent to Memory size), and press  .

4. Select Exit and press  to exit.

## Starting Measurement Sequence

Press . The **Seq Running** annunciator() turns ON.

**Warning**  Pressing  may cause the HP 4339B to output dangerous voltage, up to 1000 Vdc. Do *not* touch the UNKNOWN terminals or the electrodes of the accessory, when the V output indicator is ON.



## Aborting Measurement Sequence

Press  . The **Seq Running** annunciator() turns OFF.

## To Apply Test Voltage

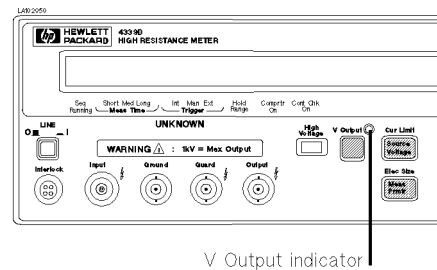
Press . The **V Output** indicator turns ON.





**Warning**  Pressing  may output dangerous voltage, up to 1000 Vdc. Do *not* touch the UNKNOWN terminals or the electrodes of the accessory when the V Output indicator is ON.

## To Trigger a Measurement

- In internal trigger mode—The HP 4339B makes continuous free-running measurements.
- In manual trigger mode—Press  when you want to trigger a measurement.
- In external trigger mode— Connect the external trigger source to the EXT TRIGGER terminal on the HP 4339B's rear panel, and apply a TTL level trigger signal to trigger a measurement. (For details, see the *HP 4339B Operation Manual*.)  
Note that the HP 4339B must be set to the external trigger mode to be triggered from an external handler or from the HP 16064B LED Display/Trigger Box.

## To Turn OFF Voltage Output

Press  and confirm the **V Output** indicator and the **High Voltage** indicator is turn OFF.

**Warning**  If the High Voltage Indicator turns ON after turning OFF the test voltage, the DUT is still charged. This happens especially for capacitive DUTs. Do *NOT* handle the DUT while the High Voltage Indicator is turned ON. When the charge on the DUT discharges to a safe level (less than 42 V) the High Voltage indicator will turn OFF.



## Reference

### Default Settings

- Test voltage output : OFF
- Test voltage : 0 V
- Current limit : 0.5 mA
- Measurement parameter : R
- Resistivity cell
  - D1 : 50 mm
  - D2 : 70 mm
  - t : 2 mm
  - B : 0
- Deviation measurement : OFF
- Measurement range : Auto
- Measurement time : MEdium
- Averaging rate : 1
- Trigger mode : Internal
- Trigger delay time : 0 ms
- Comparator : OFF
- Contact check : OFF
- Display mode : Measurement mode
- Beep mode : FAIL mode
- Offset-error canceling : OFF
- OPEN correction data is cleared

### Accessories Available

#### Test Fixtures and Test Leads

Following test fixtures and test leads are available for the HP 4339B for various forms of DUTs.

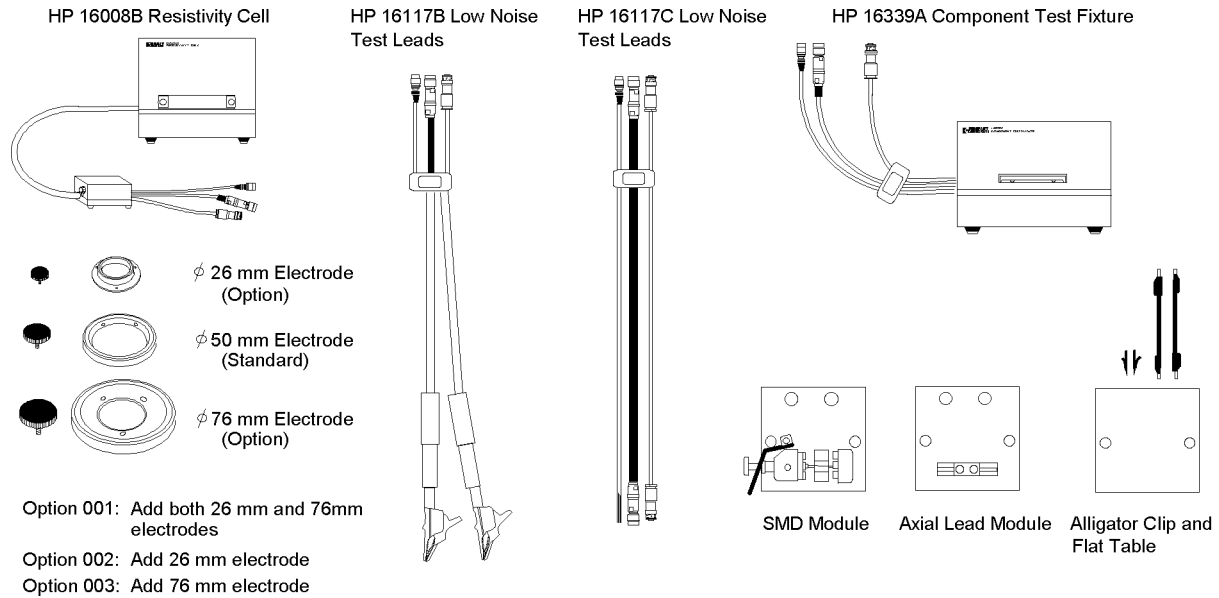

HP 16008B

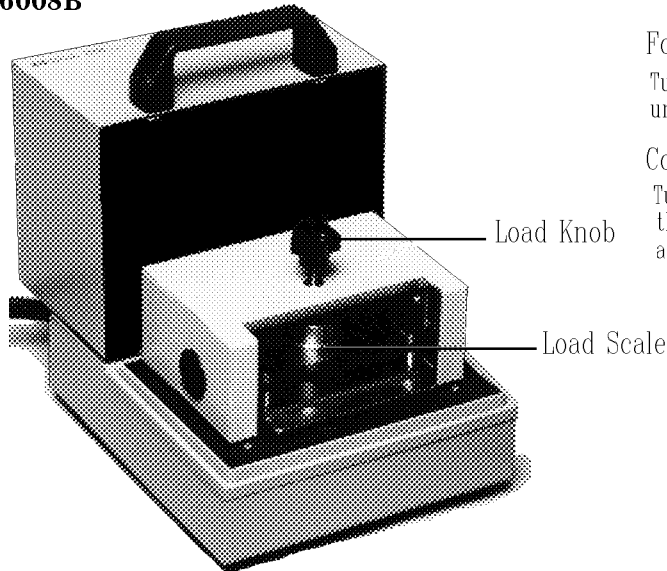

For an OPEN correction  
Turn the load knob counterclockwise until the upper electrode does not move.

Connecting the DUT  
Turn the load knob clockwise until the load scale indicates between 0 kg and 10 kg.

HP 16339A

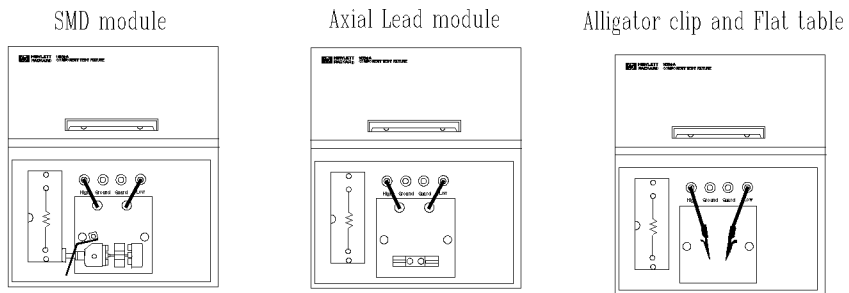

For an OPEN correction  
same as the DUT's width

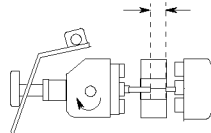

Tighten the screw to hold the electrode.

Nothing must be connected to electrode.

Remove the alligator clips.

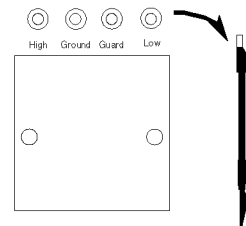

HP 16117B

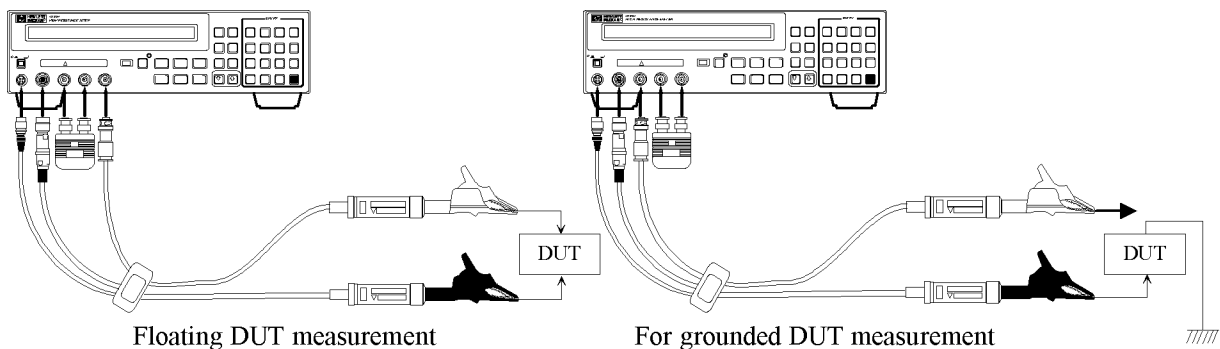

**HP 4339B**

**HP 16118A**

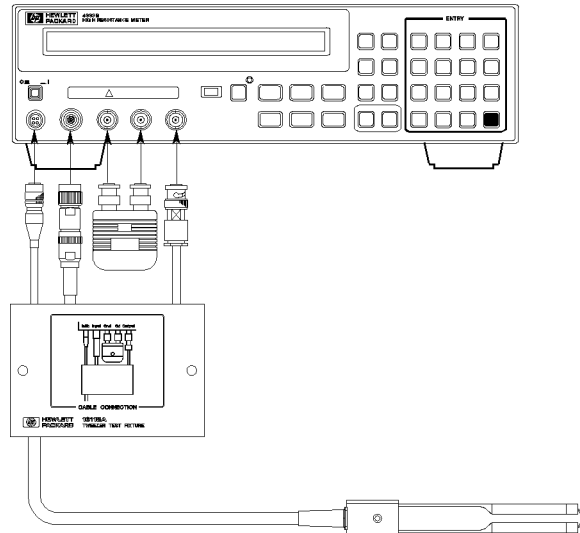

**HP 16064B LED Display/Trigger Box**

The HP 16064B LED Display/Trigger Box triggers a measurement when its trigger key is pressed, and displays the comparison results using LEDs. It allows you to manually operate the comparator function of the HP 4339B.

HP 4339B  
High Resistance Meter

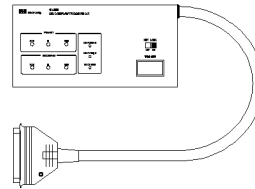
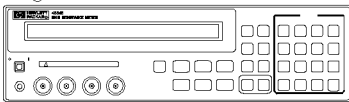

HP 16064B  
LED Display/Trigger Box



**Connect to the Handler Interface connector  
on the rear panel.**

## Other Topics

For details on these functions, see the *HP 4339B Operation Manual*.



- Initial Inspection — Chapter 1 of the *Operation Manual*
- Auto-Offset Canceling — Chapter 2 and Chapter 3 of the *Operation Manual*
- Key Lock Function — Chapter 2 and Chapter 3 of the *Operation Manual*
- HP-IB — Chapter 4 and Chapter 5 of the *Operation Manual*
- Handler Interface — Chapter 3 and Appendix B of the *Operation Manual*
- Save / Recall — Chapter 2 and Chapter 3 of the *Operation Manual*
- Backup Function — Chapter 3 of the *Operation Manual*
- Specification — Chapter 8 of the *Operation Manual*
- Maintenance — Chapter 9 of the *Operation Manual*
- Error Messages — “Error Messages” in back of the *Operation Manual*





## If You Have a Problem





If any of the problems listed below occur, follow the instructions given for the problem.

- If you find yourself lost when operating the HP 4339B

You can get back on track by:

**To return to the measurement mode** Press  several times. When Exit is in the menu, select it and press .

**To return to the default settings** Press  . Select Yes and press . If the reset is not accepted, confirm that the **Key Lock** annunciator() is turned ON. See next.

- If the HP 4339B does not accept key input:
  - Check whether or not the **Key Lock** annunciator() is ON. If so:
    - Press  . The **Key Lock** annunciator() turns OFF and the front-panel keys are unlocked.
    - Check that the HP 16064B LED display/trigger box is connected to the HP 4339B and it is set to lock out the keys. If so, unlock the keys from the HP 16064B.
- If  is not accepted:
  - Check whether the interlock connector is firmly connected.
  - If you are using the HP 16008B or the HP 16339A,
    - Check whether the top cover of the test fixture is closed.
- If ----- or “OVLd” is displayed:
 

The measurement result is out of the measurable range. Check the DUT and make sure the measurement range is properly set.



## Measurement Examples

---

### In This Chapter

The HP 4339B's features are discussed, which you can investigate by trying the typical measurement examples described in this chapter.

---

**Warning**  **Do *not* touch the UNKNOWN terminals or the electrodes of the accessory, when the High Voltage indicator is ON, the HP 4339B outputs dangerous voltage of up to 1000 Vdc. Before handling the HP 4339B or the accessory, turn OFF the test voltage pressing  and confirm that the High Voltage indicator is OFF.**

---

## Measuring Insulation Resistance of Capacitor

This example shows the procedure to measure insulation resistance of capacitor after charged 1 minute. Using the test sequence measurement function reduces the measurement complexity.

### DUT

Chip ceramic capacitor

### Requirements

Test Fixture : HP 16339A, SMD module

### Measurement Setup

Measurement Parameter : R

Measurement Range : Auto range mode

Test Voltage : 100 V

Use the measurement sequence single mode (measure after charged for 1 minute.)

### Measurement Procedure

1. Reset the HP 4339B.

a. Press   .

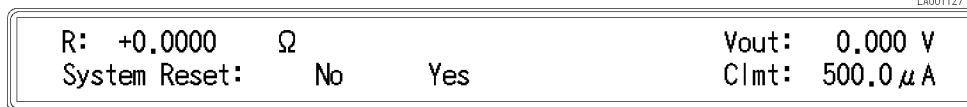

b. Select Yes using  or  and press  .

2. Connect the test fixture to the UNKNOWN terminals as follows:

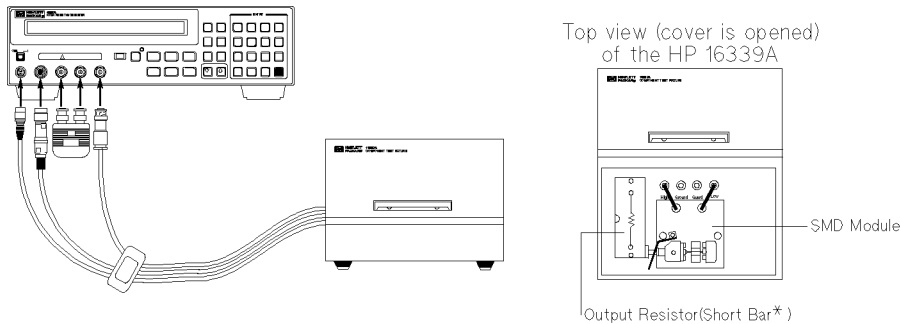

To set the SMD module :

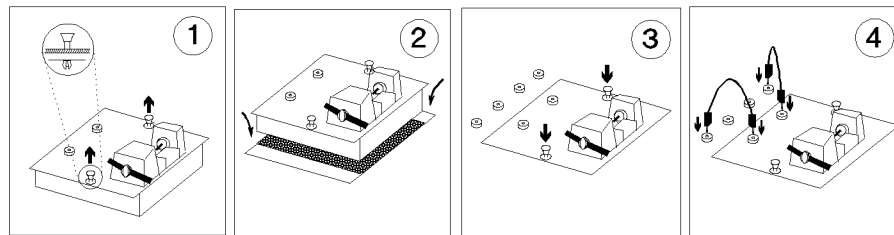

Pull the clamps up.

Insert the SMD module.

Push the clamps down.

Connect the banana cables.

\* For detail, see “HP 16339A Component Test Fixture” in Chapter 2.

3. Perform calibration.

Press   .

**HP 4339B**

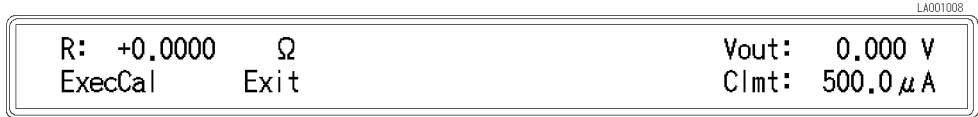

Select ExecCal using or and press . After a while, the calibration will be completed with the message “Calibration Complete”.

4. Set the test voltage.

a. Press .



b. Press to set the test voltage to 100 V.

5. Perform the OPEN correction.

a. Separate the test electrodes and fix them (nothing must be connected to the electrodes).

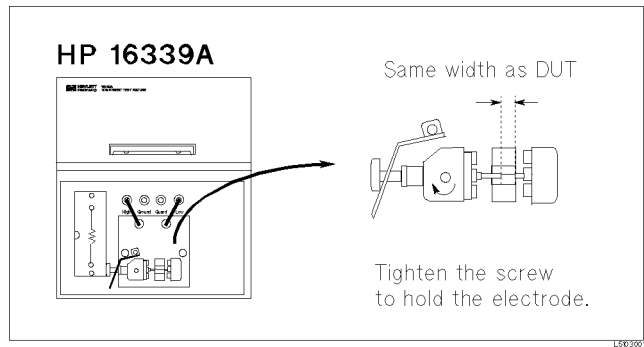

b. Close the cover.

c. Press .

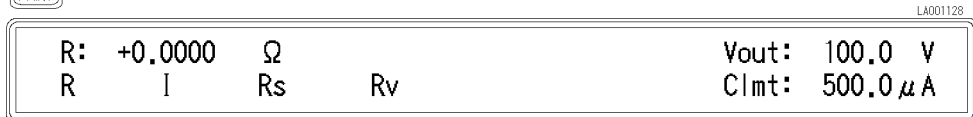

d. Select I using or and press to select the current measurement mode. displayed.

e. Press . The **Meas Time** annunciator(▼) will indicate **Long**.

f. Press to turn ON the test voltage.  
The **V Output** indicator will turn ON.

g. Wait until the I value has stabilized within 0.5 pA.

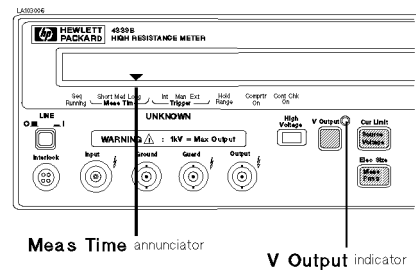

h. Press   .



i. Select OpenMeas using  or  and press  .

After a while, the OPEN correction will be completed with the message “Correction Complete”. (If Out Of Limit is displayed, see “ To Perform OPEN Correction –Canceling the stray admittance in parallel with the DUT” in Chapter 2.)

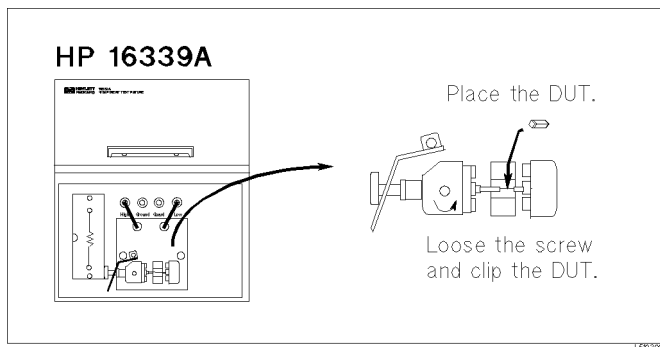

j. Press  to turn OFF the test voltage. The **V Output** indicator will turn OFF.

6. Connect the DUT and close the cover.

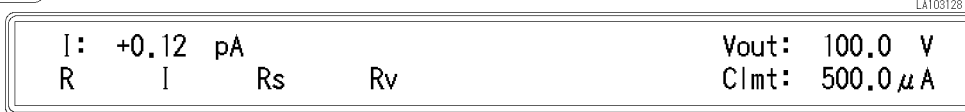

7. Press  .



8. Select R using  or  and press  to select the resistance measurement mode. R(Resistance).

9. Set the measurement sequence charging time to 1 minute.

a. Press   .

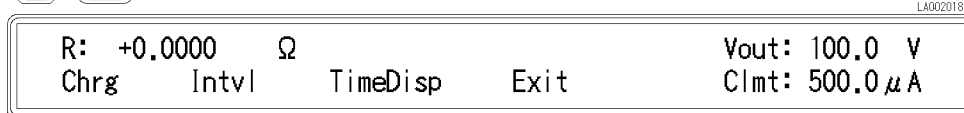

b. Select Chrg using  or  and press  .

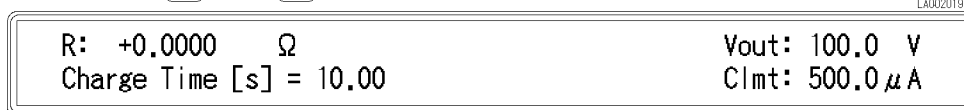

c. Press    .

d. Select Exit and press  to exit.



## HP 4339B

e. Press  .

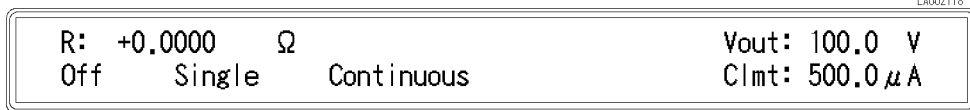

f. Select Single using  or  and press  .

10. Press  . After charging 1 minute, the measurement result will be displayed. The following figure shows the typical measurement result display.

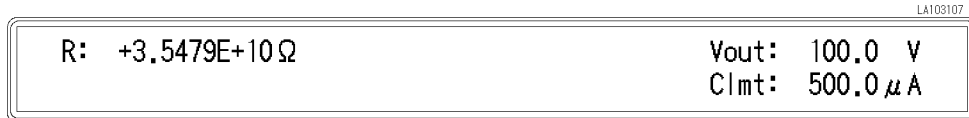

### For More Information

- To print out the measurement result — See “To Print Measurement Data” in Chapter 2
- To select measurement level — See “To Set Test Voltage” in Chapter 2

## Measuring Resistivity of Insulation Material

This example shows the procedure to measure resistivity of an insulation material after charged 1 minute. The HP 16008B Resistivity Cell is a right tool to measure resistivity of solid insulation materials.

### DUT

Insulation Material  
(5 mm × 120 mm × 120 mm)

### Requirements

Test Fixture : HP 16008B,  $\phi$  50 mm electrode

### Measurement Setup

Measurement parameter :  $R_v(\rho v)$

Measurement Range : Auto range mode

Test Voltage : 500 V



Use the measurement sequence single mode (measure after charged for 1 minute.)

### Measurement Procedure

1. Reset the HP 4339B.

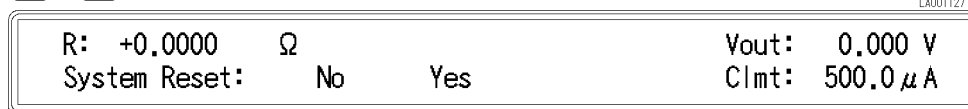
- a. Press  .



- b. Select Yes using  or  and press .

2. Connect the test fixture to the UNKNOWN terminals as follows:

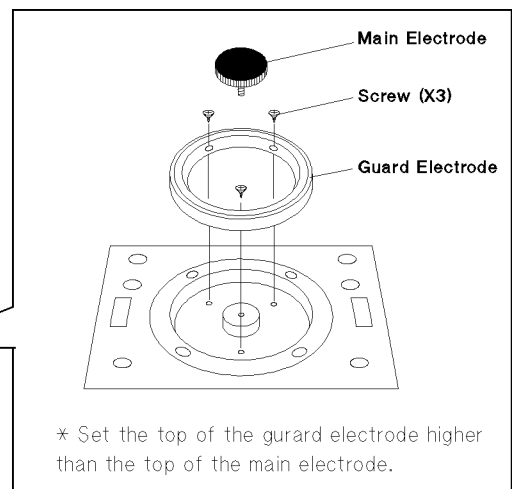
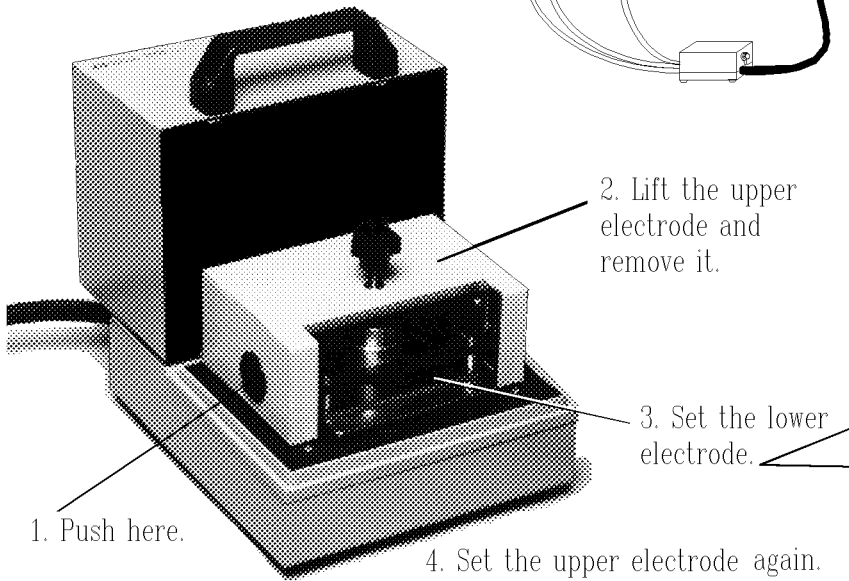
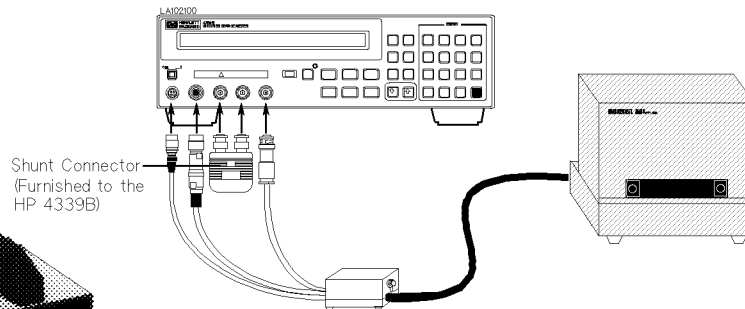

**HP 4339B**

3. Perform calibration.

a. Press  .

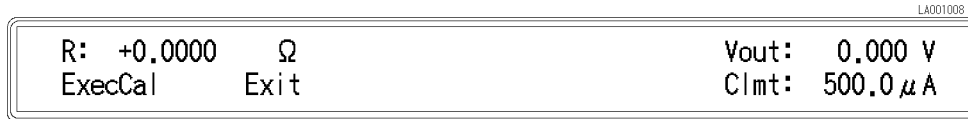

b. Select ExecCal using  or  and press .

After a while, the calibration is completed with the message "Calibration Complete".

4. Set the test voltage.

a. Press .

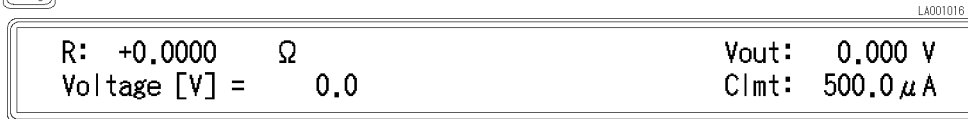

b. Press     to set the test voltage to 500 V.

5. Perform the OPEN correction.

a. Turn the load knob counterclockwise(ccw) until the upper electrode does not move.

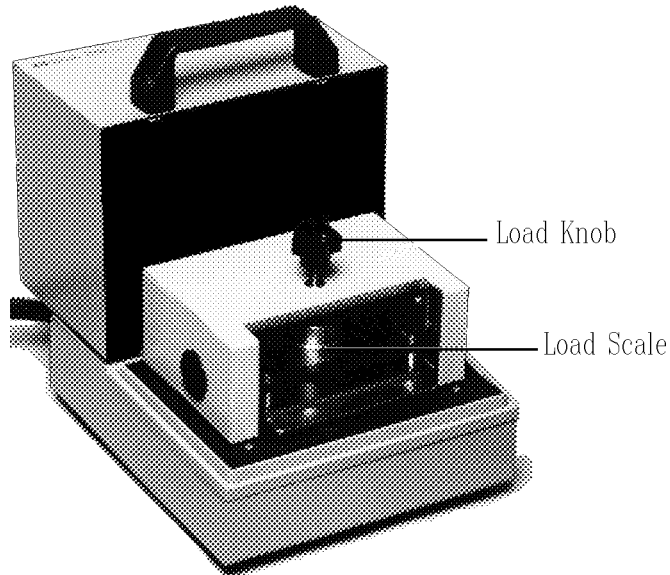

b. Close the cover.

c. Press .

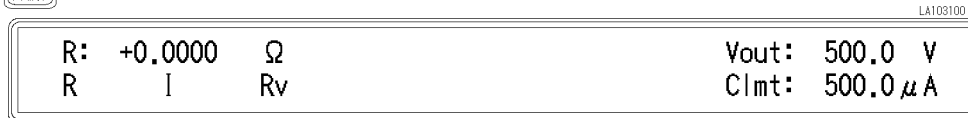

- d. Select I using or and press to select the current measurement mode.
- e. Press . The **Meas Time** annunciator() will indicate **Long**.
- f. Press . The **V Output** indicator will turn ON.
- g. Wait until the I value has stabilized within 0.5 pA.
- h. Press .

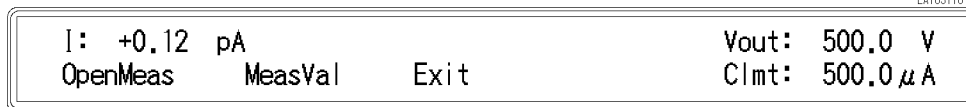
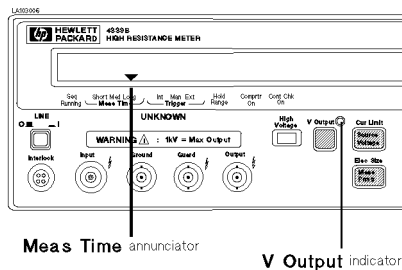

- i. Select OpenMeas using or and press . After a while, the OPEN correction is completed with the message “Correction Complete”. (If Out Of Limit is displayed, see “ To Perform OPEN Correction –Canceling the stray admittance in parallel with the DUT” in Chapter 2.)
  - j. Press . The **V Output** indicator will turn OFF.
6. Set the DUT.
- a. Place the DUT on the Main electrode.

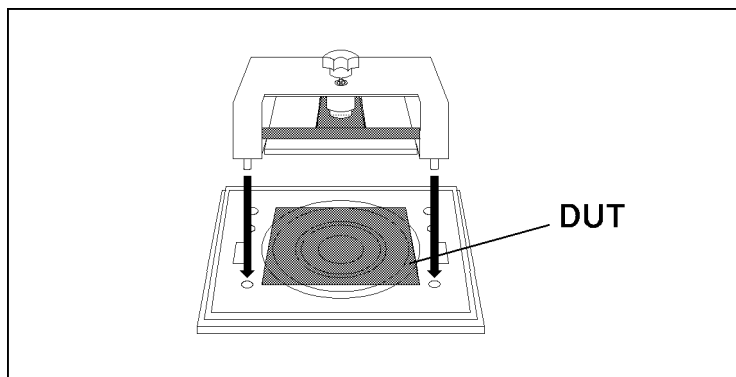

- b. Turn the load knob and stick the electrode on the DUT.(Let the load scale indicate more than 0 kg and less than 10 kg.)
  - c. Close the cover.
7. Set the measurement parameter to Rv( $\rho v$  : volume resistivity).
- a. Turn the Volume/Surface selector of the HP 16008B to “Volume”.

- b. Press .

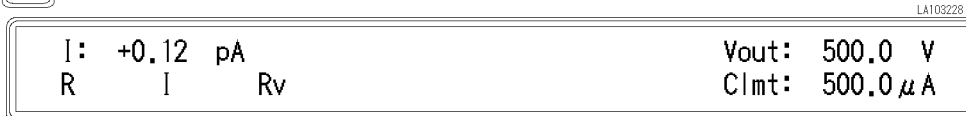



- c. Select Rv using or and press .

## HP 4339B

8. Set the measurement sequence charging time to 1 minute.

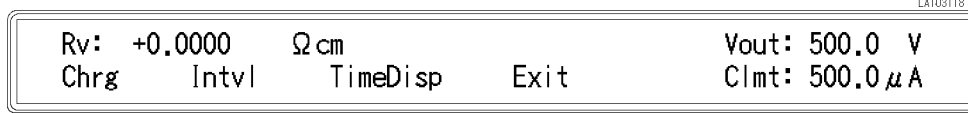
a. Press  .



b. Select Chrg and press .



c. Press   .

d. Select Exit and press  to exit.

e. Press .

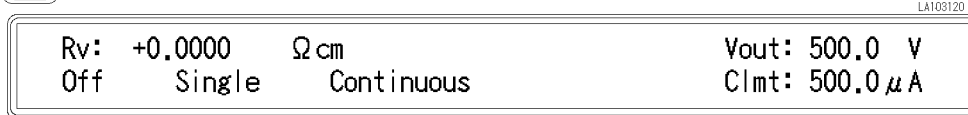

f. Select Single using  or  and press .

9. Press . After charging 1 minute, the measurement result will be displayed. The following figure shows the typical measurement result display.

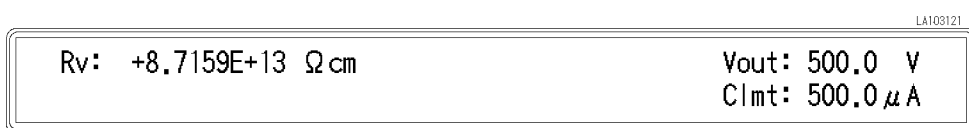

### For More Information

- To print out the measurement result — See “To Print Measurement Data” in Chapter 2
- To select other measurement parameters — See “To Select Measurement Parameter” in Chapter 2
- To select measurement level — See “To Set Test Voltage” in Chapter 2

